



Original Article

Coherence function model for tool wear monitoring

Mantana Srinang and Asa Prateepasen*

*Department of Industrial Engineering, Faculty of Engineering,
King Mongkut's University of Technology Thonburi, Bangmod, Thung Khru, Bangkok, 10140, Thailand*

Received 6 December 2006 ; Accepted 4 April 2007

Abstract

This research aimed to develop a coherence function model to describe the behaviour of coherence with tool wear. A cutting tool in turning, typically mounted as a cantilever, is used to explain the model. The dynamic forces that occur during cutting can be resolved into three mutually perpendicular components along the radial, tangential and feed directions. The theory postulated that the degree of correlation between the dynamic tangential and feed vibration components, measured as acceleration, was inversely related to the rate of tool wear. When the wear rate was high, the correlation was low. Three sets of machining tests were conducted corresponding to the roughing, semi-roughing and finishing conditions. It was observed that for roughing and semi-roughing conditions, in the frequency range of 2.5-5.5 kHz, the above-mentioned prediction of coherence turned out to be valid; for the finishing condition, there was a greater discrepancy.

Key words: Coherence function, vibration, tool wear monitoring, acceleration

1. Introduction

In machining, whether a tool needs to be changed is designed by the judgment of the machine operator based on the visual inspection of the tool and the surface finish produced on the workpiece. In automatic process replacement is based on, the fixed life expectancy of the tool, which may be premature or occur only after damage has been done.

Reliable on-line tool monitoring to provide information on the exact time of tool change is undoubtedly desirable. Various techniques for tool wear monitoring have been studied over the past few decades and can be classified into two major categories, direct and indirect methods (Dan, 1990). The direct method measures the actual tool wear, whilst the indirect method measures a parameter such as cutting forces, cutting temperature, motor current and vibration, correlated with tool wear. One of the indirect methods to measure tool wear monitoring is the coherence function of the tool acceleration signals in the tangential and feed directions. The coherence function is believed to be rela-

tively insensitive to the process variables except tool wear. The benefit of the coherence function is that its value is always between 0 to 1, hence providing some degree of normalisation, which is particularly beneficial in the situation of turning where the number of combinations of process variables is large.

The coherence function at the surrounding the resonant frequency has been used. It has been shown by empirical investment that it appeared to be sensitive to the wear process and decreased when the tool became worn (Au, 1992; Li, 1997) reported that the occurrence of severe tool wear can be predicted by the distinct increase to near unity of the coherence function between the acceleration at the first natural frequency of the tool shank. Therefore, tool wear can be used for monitoring by using the value of the threshold of the coherence function. The coherence function not only at the surrounding natural frequency but also at high frequency (up to 25 kHz) was utilized to predict the tool wear stage (Prateepasen, 2002). The coherence function at the frequency range of 0-25 kHz was divided in to 5 equally sub-frequency ranges and used as features. Then Principal Component Analysis was implemented to transform the features to the two most significant principal components

*Corresponding author.

Email address: asa.pra@kmutt.ac.th

in order to reduce the size of this database. Although, the vibration and coherence function has been used (Dan, 1990; Au, 1992; Li, 1997; Prateepasen, 2002; Dimentberg, 2006; Ulrich Sudmersen, 2006; Prateepasen, 2001; Alessandro, 2000), its model is still implicit. In this research, the coherence function model to describe the behaviour of coherence with tool wear was revealed. The degree of correlation between the dynamic tangential and feed vibration components, measured as acceleration, was exhibited in relation to the rate of tool wear. Finally, three sets of machining tests were conducted to validate the model.

2. Model of cutting forces and tool

A cutting tool in turning is typically mounted as a cantilever. The dynamic forces that occur during cutting can be resolved into three mutually perpendicular components along the radial, tangential and feed directions referred to respectively as the x-, y- and z-directions as shown in Figure 1. Since the radial force acting in the x-direction is relatively low compared to the other two forces, the tools tip mainly moves in the yz-plane. The dynamic shear force component along the shear plane is resolvable into a y-component and a z-component, and hence they are correlated. On the other hand, the dynamic friction force components that occur at the chip-tool and the tool-workpiece interfaces are mainly forces confined in the respective z- and y-directions because of the geometry of the tool and hence largely uncorrelated.



Figure 1

3. Acceleration frequency response of tool

Figure 2 shows a block diagram for single point turning in which the transfer relation between force input and acceleration output is depicted. The diagram uses the following notations:

- F_t = Fourier transform of the cutting force or tangential force = F_y
- F_f = Fourier transform of the uncorrelated part of the feed force F_z
- F_y = Fourier transform of the tangential force
- F_z = Fourier transform of the feed force
- A_y = Fourier transform of the acceleration in y direction (main cutting force direction)
- A_z = Fourier transform of the acceleration in z direction (feed force direction)
- N_y and N_z

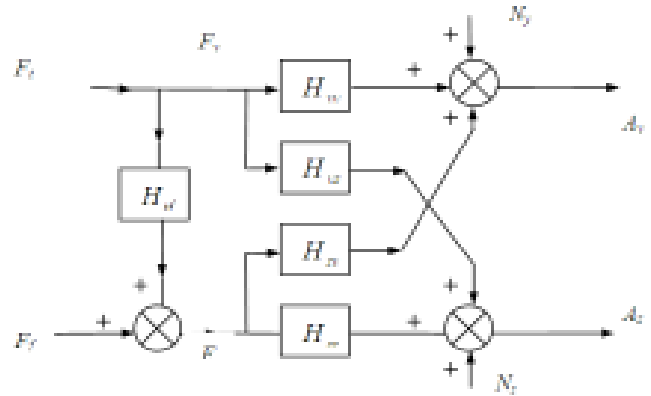

Figure 2. Block diagram of the tool wear model demonstrating the transfer relation between force input and acceleration output

= Fourier transform of the noise inputs due to instrumentation and mechanical effects.

$H_{ty}, H_{yy}, H_{yz}, H_{zy}$ and H_{zz}
= The frequency response functions representing the transfer characteristics at the tool tip from the cutting force to the acceleration.

It is noted that the variables defined above are functions of frequency.

As mentioned previously, the tangential force F_y and feed force F_z are partially correlated; the extent of correlation depends on the cutting condition and on the state of wear on the cutting tool. To model this correlation, two dynamic forces F_t and F_f as shown in Figure 1, are used. Using the frequency response function H_{ty} , the correlation between F_y and F_z is produced. Thus

$$F_y = F_t \tag{1}$$

and $F_z = H_{ty}F_t + F_f \tag{2}$

When F_y acts on the tool tip, it causes vibration in both y- and z- directions. The transfer relationship in these directions is represented by the frequency response functions H_{yy} and H_{yz} respectively. Similarly, F_z produces vibration through the frequency response functions H_{zz} and H_{zy} . The system is assumed to be linear, and the principle of reciprocity applies, leading to $H_{yz} = H_{zy}$. Finally noise sources arising from the electronic instrumentation and the mechanical motion of the machine tool are represented by N_y and N_z .

From the block diagram in Figure 1, the acceleration in the y-direction (main cutting force direction) can be defined as

$$A_y = H_{yy}F_y + H_{zy}F_z + N_y.$$

Substituting Equations (1) and (2) for F_y and F_z yields

$$A_y = H_{yy}F_t + H_{zy}(H_{ty}F_t + F_f) + N_y$$

Collecting terms gives

$$A_y = (H_{yy} + H_{zy}H_{ty})F_t + H_{zy}F_f + N_y. \tag{3}$$

Similarly, the acceleration in the z-direction (feed force direction) can be expressed as

$$A_z = H_{zz} F_z + H_{yz} F_y + N_z$$

$$A_z = H_{zz} (H_{yf} F_t + F_f) + H_{yz} F_t + N_z$$

and

$$A_z = (H_{zz} H_{yf} + H_{yz}) F_t + H_{zz} F_f + N_z \quad (4)$$

Multiplying A_y by its complex conjugate, A_y^* , one obtains

$$\begin{aligned} A_y A_y^* &= [(H_{yy} + H_{zy} H_{yf}) F_t + H_{zy} F_f + N_y] [(H_{yy} + H_{zy} H_{yf})^* F_t^* + H_{zy}^* F_f^* + N_y^*] \\ &= |H_{yy} + H_{zy} H_{yf}|^2 (F_t F_t^*) + |H_{zy}|^2 (F_f F_f^*) + (N_y N_y^*) \\ &\quad + H_{zy}^* (H_{yy} + H_{zy} H_{yf}) (F_t F_f^*) + (H_{yy} + H_{zy} H_{yf}) (F_t N_y^*) \\ &\quad + H_{zy} (H_{yy} + H_{zy} H_{yf}) (F_f F_t^*) + H_{zy} (F_f N_y^*) \\ &\quad + (H_{yy} + H_{zy} H_{yf})^* (F_t^* N_y) + H_{zy}^* (F_f^* N_y). \end{aligned}$$

In the Equation, $|x|$ means the absolute value of x .

The corresponding autospectrum is by definition,

$$G_y = \lim_{T \rightarrow \infty} \frac{2}{T} E[A_y A_y^*] \quad (5)$$

Since F_t and F_f and N_y are uncorrelated

$$E[F_t F_f^*] = E[F_t N_y^*] = E[F_f F_t^*] = E[F_f N_y^*] = E[F_t^* N_y] = E[F_f^* N_y] = 0$$

resulting in

$$G_y = 2[|H_{yy} + H_{zy} H_{yf}|^2 S_t + |H_{zy}|^2 S_f + S_{ny}] \quad (6)$$

where S_t, S_f and S_{ny} are the auto spectra of F_t, F_f and N_y , defined in an analogous fashion to Equation (5)

Similarly G_z can be shown to be:

$$G_z = 2[|H_{yz} + H_{zz} H_{yf}|^2 S_t + |H_{zz}|^2 S_f + S_{nz}] \quad (7)$$

where S_{nz} are the auto spectra of N_z , with a definition analogous to Equation (5)

The cross spectrum between A_y and A_z can be found by calculating $A_y A_z^*$, where A_z^* is the complex conjugate of A_z . Following a similar procedure of derivation to that for G_y , we obtain

$$G_{yz} = 2[(H_{zy} H_{yf} + H_{yy})(H_{zz} H_{yf} + H_{yz})^* S_t + H_{zy} H_{zz}^* S_f] \quad (8)$$

4. Coherence Function of the tool acceleration (γ^2)

The coherence function between the two acceleration outputs A_y and A_z signals is defined as

$$\gamma^2 = |G_{yz}|^2 / G_y G_z \quad (9)$$

or, on substitution,

$$\gamma^2 = \frac{|H_{yy} + H_{zy} H_{yf}|^2 |H_{yz} + H_{zz} H_{yf}|^2 S_t^2 + |H_{zy} H_{zz}|^2 S_f^2}{[|H_{yy} + H_{zy} H_{yf}|^2 S_t + |H_{zy}|^2 S_f + S_{ny}][|H_{yz} + H_{zz} H_{yf}|^2 S_t + |H_{zz}|^2 S_f + S_{nz}]} \quad (10)$$

It can be seen from Equation (10) that the presence of noise reduces the coherence function. The reason is that the noise terms S_{ny} and S_{nz} being associated with G_y and G_z both appear in the denominator of the Equation 10. To make the analysis simple, we shall now ignore the effects of noise; that is the noise terms are removed from Equation (10).

Since $|H_{yz}|$ is much smaller than either $|H_{yy}|$ or $|H_{zz}|$ in the vicinity of the resonance frequencies of the tool in the y- and z-directions, we shall assume $|H_{yz}| = 0$. Thus Equation 10 simplifies to

$$\gamma^2 = \frac{|H_{yy}|^2 S_t^2 |H_{zz} H_{tf}|^2}{|H_{yy}|^2 S_t [|H_{zz} H_{tf}|^2 S_t + |H_{zz}|^2 S_f]}$$

H_{yy} and H_{zz} being the frequency response functions of the cutting tool are not a function of wear. Furthermore defining

$$\alpha = \frac{S_f}{S_t} \tag{11}$$

the coherence function can be simply written as

$$\gamma^2 = \frac{|H_{tf}|^2}{|H_{tf}|^2 + \alpha} \tag{12}$$

To find out how γ^2 changes with $|H_{tf}|$ and α , it is observed that the total differential, from Equation (12) is

$$d\gamma^2 = \frac{\partial \gamma^2}{\partial (|H_{tf}|^2)} d(|H_{tf}|^2) + \frac{\partial \gamma^2}{\partial \alpha} d\alpha \tag{13}$$

where

$$\frac{\partial \gamma^2}{\partial (|H_{tf}|^2)} = \frac{\alpha}{(|H_{tf}|^2 + \alpha)^2} > 0 \tag{14}$$

and

$$\frac{\partial \gamma^2}{\partial \alpha} = -\frac{|H_{tf}|^2}{(|H_{tf}|^2 + \alpha)^2} < 0 \tag{15}$$

From Equation (14) and (15), It can be concluded that increasing the value of (H_{tf}) and decreasing the value of α , both cause the coherence function γ^2 to rise in value.

As a tool begins to wear, the extent of correlation between F_y and F_z varies. It is reasonable to postulate that the correlation, as represented by H_{tf} in Figure 1, is inversely related to the wear rate on the cutting edge of the tool. The second

postulate is that the ratio $\alpha = \frac{S_f}{S_t}$ remains approximately constant with the progression of wear in the frequency band around the resonance of the cutting tool.

The first postulate suggests that when the cutting edge is wearing quickly, the correlation between F_y and F_z is small, meaning H_{tf} is also small, and vice versa. A graph of flank wear against machining time has the characteristic shape as shown in Figure 3.

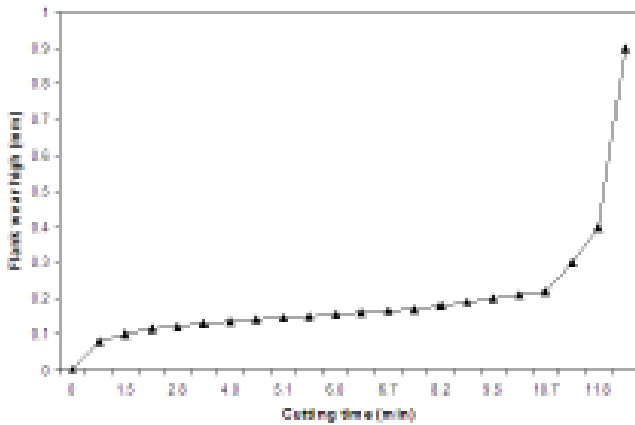

Figure 3. Characteristic shape of flank wear against machining time (from machining test at speed 250 m/min depth of cut 0.75 mm and feed rate 0.25 mm/rev).

The gradient of this curve is the wear rate and the graph of wear rate versus time looks like Figure 4.

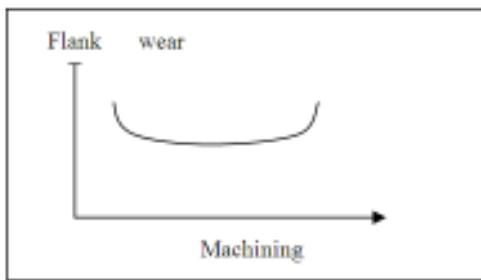

Figure 4. Typical wear rate versus time.

H_{ff} is just the opposite of flank wear rate and so it looks like Figure 5.

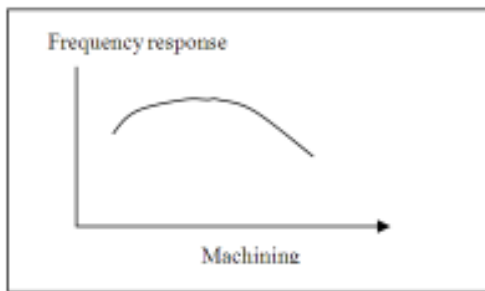

Figure 5. Typical of frequency response function (H_{ff}) versus time.

The second postulate of constant appears to be acceptable. The reason is that the autospectra, S_f and S_t , correspond to the uncorrelated friction forces on the two interfaces and that tool wear is likely to affect equally both S_f and S_t .

Since, by Equation (12), both H_{ff} and the γ^2 have the same trend, it can be concluded that the value of the coherence function γ^2 is low when the tool is sharp, rises to a higher level during the secondary stage of tool wear when the wear rate is constant, and then falls in the tertiary stage when the cutting edge crumples rapidly leading to eventual failure.

5. Experimental Setup

To validate the theory of coherence function, cutting experiments were performed. Their conditions are as described below.

Machine Test Set Number	cutting speed (m/min)	feed (mm/rev)	depth of cut (mm)
1) Roughing	150	0.3	1
2) Semi- Roughing	250	0.25	0.75
3) Finishing	300	0.2	0.5

5.1 Cutting conditions of three machining test sets.

Two compact accelerometers model (PCB303A03) were mounted at the insert end of tool shank: one in the direction of tangential force and the other in the direction of feed force. They have the frequency ranges of 1-10,000 Hz (5%) and 0.7-20,000 Hz (10%). They are designed for adhesive mounting. Due to the high temperature, glass-ceramic-discs measured 10x1 mm², were used as heat insulators between the tool shank and the accelerometers. A silicone rubber compound which can be withstand temperature up to 25°C was used as a couplant between the accelerometers and glass-ceramic insulators. The accelerometer outputs of the accelerometers were fed into the SI 1220 multi-channel spectrum analyser, set to display an average spectrum over 8 successive spectra in the frequency range 0Hz-25kHz with the resolution of 500 points. The experimental setup is shown in Figure 6.

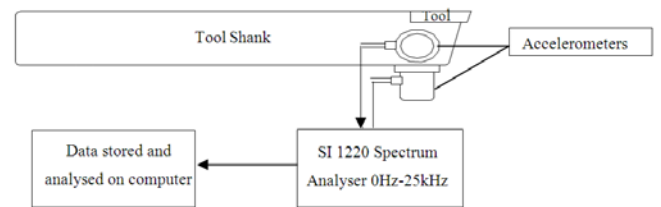

Figure 6.

For each set of machining tests, a fresh insert (GC 4035) was used and cuts were performed until the insert was considered to be worn. Acceleration signals in the feed and tangential directions were recorded for every other cut.

The coherence spectra of the acceleration signals for each of the three machining conditions are shown in Figures 7a, 8a and 9a as waterfall plots. The three axes in

these diagrams represent the frequency, the cutting time and the coherence. An alternative, maybe better, perspective to the waterfall plot is to take a plan view of the waterfall plot using colours to code the values of the coherence function. These corresponding plan views are shown in Figures 7b, 8b and 9b.

For roughing cuts, it can be seen from Figure 7a that in the frequency range of 2.5 to 5.5 kHz, the coherence values rise rapidly in the initial stage of tool wear, stay at a high plateau value in the secondary stage and then fall in the tertiary stage. This pattern is repeated, Figure 8a, for semi-roughing cuts; and, to a lesser extent, for the finishing cuts, Figure 9a. As expected, the curves corresponding to coherence in the 2.5-5.5 kHz frequency range in Figures 10, 11 and 12 bear out the same fact. The pattern of coherence values agrees with the theory proposed previously.

6. Conclusions

In this research, a coherence function model was developed to describe the relation between coherence and tool wear. It was expected that in the resonant frequency region of the cutting tool, the coherence values would rise in the initial stage of tool wear, would stay in a higher plateau value in the secondary stage and would fall in the tertiary stage. Both the initial and tertiary stages of tool wear were observed to be very short in comparison to the secondary

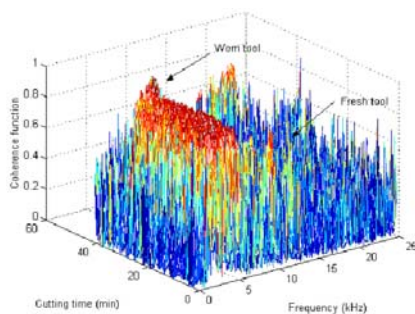

Figure 7a. Three-dimension plot of the coherence spectra of the accelerations in the tangential and feed directions of roughing cuts

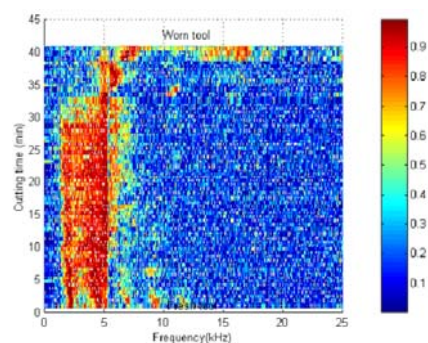

Figure 7b. Plane view plot of the coherence spectra of the accelerations in the tangential and feed directions of roughing cuts

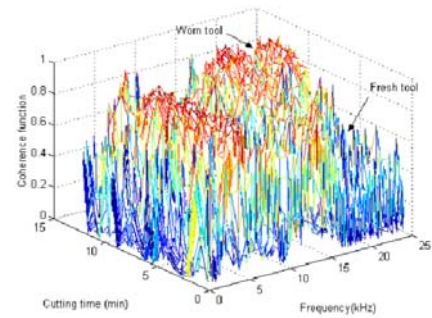

Figure 8a. Three-dimension plot of the coherence spectra of the accelerations in the tangential and feed directions of semi-roughing cuts

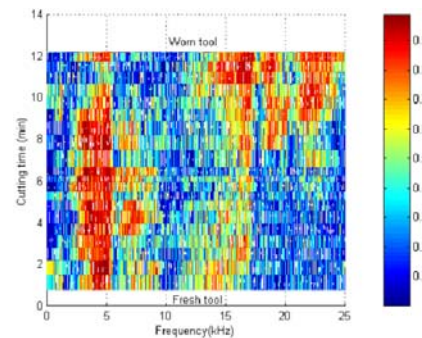

Figure 8b. Plane view plot of the coherence spectra of the accelerations in the tangential and feed directions of semi-roughing cuts

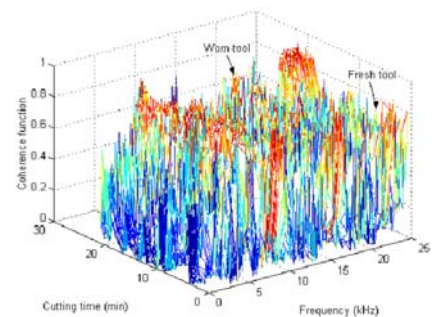

Figure 9a. Three-dimension plot of the coherence spectra of the accelerations in the tangential and feed directions of finishing cuts

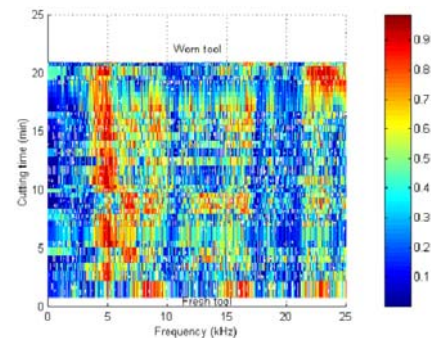

Figure 9b. Plane view plot of the coherence spectra of the accelerations in the tangential and feed directions of finishing cuts

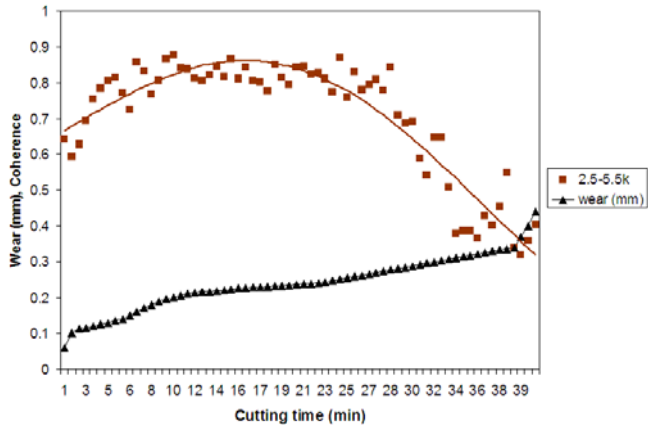

Figure 10. Coherence at frequency range 2.5-5.5 kHz and flank wear with cutting time of cutting speed 150 m/min depth of cut 1.0 mm and feed rate 0.3 mm/rev.

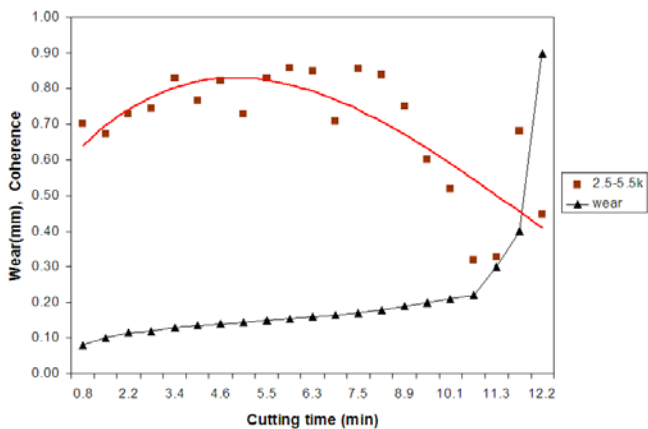

Figure 11. Coherence at frequency range 2.5-5.5 kHz and flank wear with cutting time of cutting speed 250 m/min depth of cut 0.75 mm and feed rate 0.25 mm/rev.

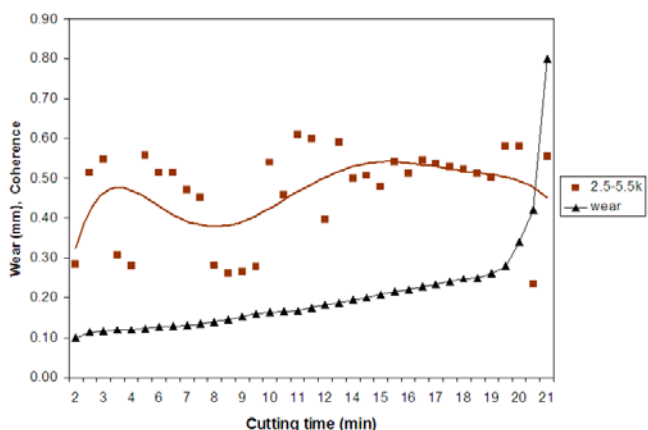

Figure 12. Coherence at frequency range 2.5-5.5 kHz and flank wear with cutting time of cutting speed 300 m/min depth of cut 0.5 mm and feed rate 0.2 mm/rev.

stage.

The theory postulated that the degree of correlation between the dynamic tangential and feed vibration components, measured as acceleration, was inversely related to the rate of tool wear. When the wear rate was high, as would be the case in the initial and tertiary stages of tool wear, the correlation was low; that, in turn, according to the theory, would give a low coherence. When the wear rate was low during the secondary stage of wear, the correlation and its corresponding coherence would then be high.

Three sets of machining tests were performed to confirm the coherence function model. It was found that for roughing and semi-roughing conditions, in the frequency range of 2.5-5.5 kHz, the above-mentioned prediction of coherence turned out to be valid; for the finishing condition, there was a greater discrepancy.

Acknowledgements

The authors wish to acknowledge Brunel Center of Manufacturing Metrology of Brunel University to support all equipments and Dr. Joe Au for his comment.

References

- Dan, L. and Mathew, J. 1990. Tool wear and failure monitoring techniques for turning-a review. 1st J. Mach. Tools Manufact, 30 (4) : 579-598.
- Au, Y.H.J. and Owen, C. 1992. "Coherence analysis for tool wear monitoring, Part2-Results and wear state classification", Proceeding of International Conference COMADEM92, 15-17 July 1992.
- Li X.Q., Wong, Y.S. and Nee, A.Y.C. 1997. "Tool wear and chatter detection using the coherence function of two crossed acceleration". International Journal of Machine Tools and Manufacture, 37(4), pp.425-435.
- Prateepasen, A. 2002. Principle Component Analysis of Coherences Function for Tool Wear Monitorig. Seven International Pacific Conference on Manufacturing & Management, November 27-29, 2002, Bangkok, Thailand. 396-401.
- Dimentberg, M.F., Iourtchenko, D.V., and Naess A, 2006. "Coherence function of transverse random vibrations of a rotating shaft", Journal of Sound and Vibration, 292 (3-5), p. 983-986.
- Sudmersen, U. 2006. Vibration Monitoring for Process Control an Optimization in Production Lines. 9th European Conference on NDT - September 2006 - Berlin, Germany
- Prateepasen, A., Au, Y. H. J., and Jones, B. E. 2001. Acoustic Emission and Vibration for Tool Wear Monitoring in Single-Point Machining Using Belief Network. Instrumentation and Measurement Technology Conference, May 21-23, 2001, Budapest, Hungary
- Alessandro, B. 2000. Tool Wear in Drilling Machines. 7th International Congress on Sound and Vibration, Garmisch, P. 551-557