



*Original Article*

## A comparison study on elasticity of rubberized concrete with and without poly (ethylene terephthalate) fibre

Apidej Sakulneya and Pitiwat Wattanachai\*

*Department of Civil Engineering, Faculty of Engineering,  
Chiang Mai University, Mueang, Chiang Mai, 50200 Thailand*

Received: 20 July 2016; Revised: 26 January 2017; Accepted: 3 February 2017

---

### Abstract

This research aimed to study the behaviour of concrete after adding recyclable waste materials into the mixture. According to a number of studies and reports widely published on crumb rubber and **poly** (ethylene terephthalate) (PET) fibre, both materials were of interest for this study. Based on a structured mixing of 7 different proportions of crumb rubber with 2 different proportions of PET fibre, samples of 108 concrete cylinders were collected for testing on compressive strength. Flexibility and ductility were tested on 6 specimens of concrete beams, and the strain contour of 6 reinforced concrete beams of 2 meters length were evaluated. As a result, it was found that concrete with recycled materials had lower compressive strength than conventional concrete. Moreover, the finding in terms of flexibility, energy dissipation, and strain capacity revealed that adding PET fibre and crumb rubber significantly improved the performance of conventional concrete.

**Keywords:** energy dissipation, rubberized concrete, PET fibre, image analysis, strain contour

---

### 1. Introduction

Thailand is one of the developing countries in Southeast Asia. It has a countless number of industrial factories of tyre and plastic materials. Meanwhile, as the population increases along with ongoing economic development, an increased per capita consumption of merchandise is concurrently obvious. As the result of a modern lifestyle rapidly changing toward new technology, many consumer goods are made of increased amounts of non-biodegradable materials, such as rubber and plastics, used mostly for packaging and containers. Consequently, these materials have become residual substances and have brought numerous problems for local waste management authorities. Data published on 12 January 2015 by the Pollution Control Department showed that 77 provinces in Thailand had cumulative waste of around 14.8 million tons with the amount of waste materials increasing at 26.1 million tons per year.

Moreover, only 4.8 million tons (18.41%) could actually be recycled as waste utilization, whereas the rest went into various processes of waste disposal, i.e. burning, landfills, and placing in waste collecting areas, handled by various government bodies. At present, waste management in almost every Thai community seems to be an important national priority. Therefore, research regarding waste utilization on any relevant topic, to a certain extent, will certainly contribute to tackling this problem.

This research aimed to determine the environmental impact on society with regard to applying crumb rubber and poly (ethylene terephthalate) (PET) fibre in a concrete mixture and the advantages from an engineering aspect.

In this study, crumb rubber was used to replace fine aggregate in a concrete mixture. Existing research results show that while the rubberized concrete significantly improves the performance of conventional concrete in hysteresis damping and energy dissipation (Hernández *et al.*, 2007; Kaloush *et al.*, 2005; Youssf *et al.*, 2015), it can deteriorate the mechanical properties such as the compressive strength (Bentayneh *et al.*, 2008; Siddique *et al.*, 2004). In order to rule out such weaknesses, this research was conducted adding recycled PET fibre in rubberized concrete to regain some of the mecha-

---

\*Corresponding author

Email address: [pitiwat@step.cmu.ac.th](mailto:pitiwat@step.cmu.ac.th)

nical and engineering properties of concrete (Foti, 2011; Fraternali *et al.*, 2011; Kim *et al.*, 2010; Ochi *et al.*, 2007; Pacheco *et al.*, 2012; Pereira-de-Oliveira *et al.*, 2011). In this study, comparisons were observed among rubberized concrete, containing PET fibre, and conventional concrete in a set of mixtures using reliable and valid tools, equipment, and machines. Testing was also performed to determine the compressive strength of concrete, flexural strength of concrete beams, and flexural strength of reinforced concrete beams. The relevant data evaluated from the tests included the modulus of rupture, first crack strength, ductility index, energy dissipation, and strain contour of the beams.

## 2. Materials and Methods

### 2.1 Concrete mix

The concrete mix proportion requirements are shown in Table 1a. A mixed design for conventional concrete was used as a reference. A water-to-cement ratio (W/C) of 0.397 was set as a reference in the mix design. Coarse aggregate with a maximum size of 20 mm was used. High range water-reducing concrete and retarding concrete admixtures at 1500 cc. per 100 kg and 200 cc. per 100 kg of cement weight were used, respectively. The portion of fine aggregate to total aggregate was 43% by volume. The variety of samples and the replacement of crumb rubber and PET fibre are shown in Table 1b.

Table 1a. Concrete mix proportion requirements.

Concrete Mix Requirements	
W/C	0.397
Maximum size of aggregate	20 mm (3/4")
S/A	43%
Portland Cement Type	3
Admixture	Superplasticizer 1500 ml/100 kg of cement Retarder 200 ml/100 kg of cement

Table 1b. Mix proportions of concrete.

Specimens	Mix proportion of concrete	
	Replacement of recyclable material (%)	
	Recycled PET (by volume of concrete)	Crumb Rubber (by volume of fine aggregate)
CC	-	-
PIR100	1	100
PIR75	1	75
PIR50	1	50
PIR25	1	25
PIR8	1	8
PIR4	1	4
PIR2	1	2
P0.5R8	0.5	8
P0.5R4	0.5	4
P0.5R2	0.5	2
R8	-	8

### 2.2. Recycled PET fibre

PET fibre is a recyclable material produced by the esterification process, pre-polymerization process, and polymerization process. Pieces of PET fibre (3–5 mm long) used in this experiment were derived from recycled drinking water bottles.

### 2.3. Crumb rubber

Crumb rubber particles in this experiment were recycled from vehicle tyres with sizes ranging from 10 mesh to 30 mesh.

### 2.4. Preparation of concrete samplings

#### 2.4.1. First series of experiments

(1) A concrete mix design for the reference concrete was provided. At day 7, the compressive strength must be higher than 325 kg/cm<sup>2</sup> molded in cubes or equivalent to 275 kg/cm<sup>2</sup> molded in cylinders because it is the minimum requirement of compressive strength for rigid pavement set by the Department of Highways Thailand. (Department of Highways [DOH], 2001).

(2) Cylinder samplings of conventional concrete and rubberized concrete ranging from 2 to 100% of crumb rubber and 1% of PET fibre were collected.

(3) The proportion of crumb rubber was selected to provide the appropriate compressive strength and then the amount of PET fibre was varied from 0.5 to 1% in the rubberized concrete.

#### 2.4.2. Second series of experiments

(1) One of the maximum replacements was selected from the previous step that exceeded the requirements of compressive strength from the first experiment.

(2) Specimens of plain concrete, rubberized concrete, and rubberized concrete with PET fibre were cast (Table 2).

Table 2. Specimens in second series of experiments.

Mix/Test	Design of Experiment (No. of sample)	
	Flexural test on prismatic concrete beam	Flexural test on reinforced concrete beam
CC	2	2
R8	2	2
PIR8	2	2

### 2.5 Testing methods

2.5.1. ASTM C31 standard practice for making and curing concrete test specimens in the field.

2.5.2. ASTM C39 standard test method for compressive strength of cylindrical concrete specimens.

2.5.3. ASTM C78 standard test method for flexural strength of concrete (Using simple beam with third point loading)

2.5.4. ASTM C192 standard practice for making and curing concrete test specimens in the laboratory.

2.5.5. Flexural strength of reinforced concrete beam with fourth point loading as mentioned in 3.3 (Figure 1).

2.5.6. Image analysis method

Strain contour was determined by the image analysis method following these specifications.

(1) DSLR camera specification should be equivalent to Canon 5D mark II or higher. Also, remote shutter should be available.

(2) Distance between reinforced concrete beam and the camera is not greater than 1 meter.

(3) Reference nodes on reinforced concrete beam must be assembled as shown in Figure 2. Distance between each node should not exceed 20 mm.

(4) Strain contour was analyzed by programming in MATLAB.

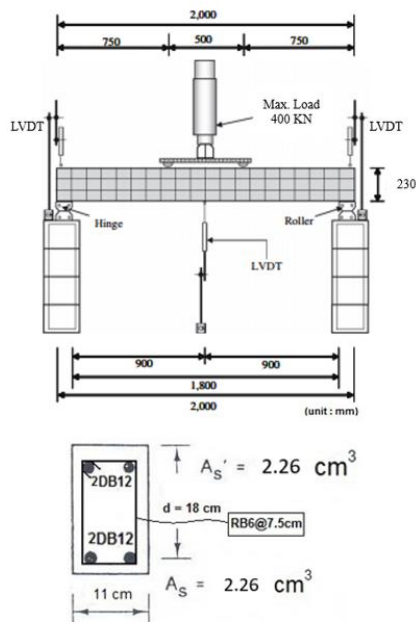

Figure 1. Details of reinforced concrete specimens.

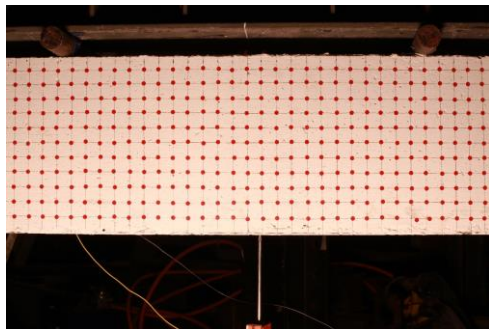

Figure 2. Node assembly demonstration.

### 3. Results and Discussion

#### 3.1. Compressive strength

The compressive strengths of the cylindrical specimens with a diameter of 100 mm were investigated after 3, 7, and 28 days of curing.

Table 3 shows the results of the compression test on 12 different proportions of specimens. A comparative chart in Figure 3 suggested that the applicable value of crumb rubber should not exceed 8% to meet the requirement.

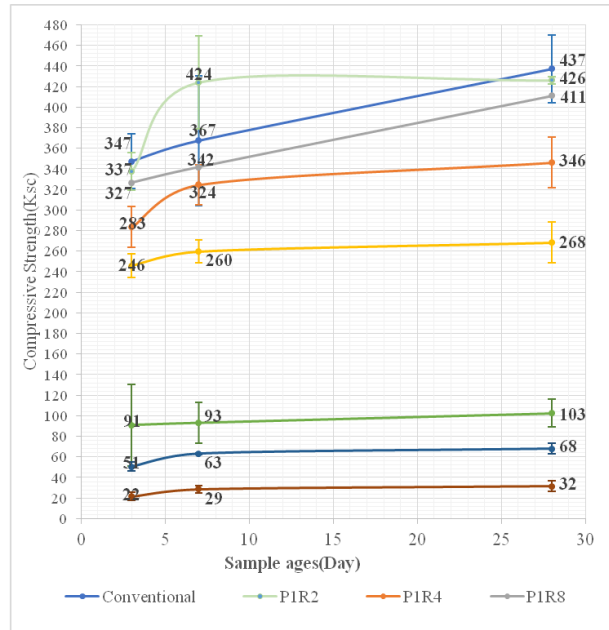

Figure 3. Compressive strength of concrete with 1% volume fraction of PET fibre.

#### 3.2. Flexural strength and energy dissipation of prismatic concrete beam

After 28 days of curing, three point bending tests were observed on 100×100×500 mm prismatic beams based on ASTM C78. Three different mix proportions were used in this test, whereas two specimens of each CC, R8, and PIR8 were cast. A load on the specimens was done by a universal testing machine and the deflection at the mid-span of the beam was measured by dial indicator. As a result of the test, the relationship between the load and deflection of the prismatic beam is presented in Figure 4. A maximum load of each sample is illustrated in Table 4. The flexural strength of PIR8 was 22.13% and 24.71% higher than R8 and CC, respectively. Moreover, it was observed that when the load reached its peak level, R8 was consequently unable to bear the load and suddenly collapsed with a lower maximum deflection than the CC. Compared to PIR8, it performed outstandingly with strain energy capacity to handle the load after the ultimate strength reached. Also, it had the highest energy dissipation compared to the others.

Table 3. Results of compression tests.

CODE	Compressive Strength (Ksc.)														
	3 days Compressive strength					7 days Compressive strength					28 days Compressive strength				
	1	2	3	Average	SD	1	2	3	Average	SD	1	2	3	Average	SD
CC	377	328	336	347	26.42	364	306	432	367	63.27	402	466	443	437	32.54
P0.5R2	324	389	311	342	41.79	370	435	454	420	44.17	454	409	467	443	30.67
P1R2	0	350	324	337	18.36	376	428	467	424	45.58	428	428	422	426	3.75
P0.5R4	428	311	324	355	64.02	363	396	389	383	17.17	350	461	389	400	55.95
P1R4	279	305	266	283	19.83	324	344	305	324	19.47	318	357	363	346	24.57
P0.5R8	0	260	260	260	0.00	337	350	363	350	12.98	344	422	383	383	38.94
P1R8	324	357	299	327	29.26	350	350	324	342	14.99	415	376	441	411	32.66
R8	264	257	226	249	19.97	270	355	311	312	42.46	351	405	396	384	28.84
P1R25	234	247	257	246	11.71	266	247	266	260	11.24	273	286	247	268	19.83
P1R50	136	71	65	91	39.47	110	97	71	93	19.83	110	110	87	103	13.49
P1R75	45	53	53	51	4.50	64	64	62	63	0.75	74	65	65	68	5.25
P1R100	19	19	26	22	3.75	31	25	30	29	3.43	32	36	26	32	5.25

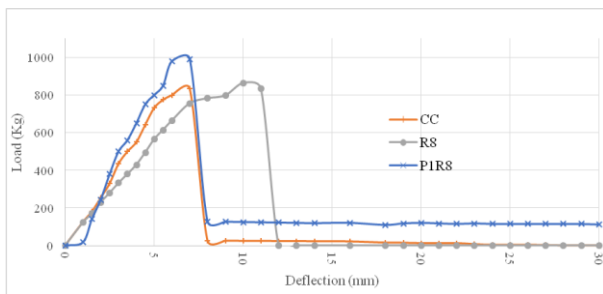

Figure 4. Load-deflection of prismatic concrete beams

Table 4. Flexural strength of prismatic beam.

Specimen	CC1	CC2	R8/1	R8/2	P1R8/1	P1R8/2
Load (kg)	780	835	864	785	992	1022
	807.5		824.5		1007	

### 3.3. Flexural strength, ductility index, energy dissipation, and strain analysis of reinforced concrete beam

The details and dimensions of the reinforced concrete specimens are depicted in Figure 1. Figure 5 demonstrates the experimental set-up for the reinforced concrete beam with image analysis.

Six samples of reinforced concrete beam were evaluated after 28 days from casting. The samples with hinge-roller support were tested by load on a proving ring with a maximum load capacity of 40000 Kg. Strain gauges attached on the beam can be seen in Figure 6. Three linear variable differential transducers were installed, one at the middle of the

beam and one at each end of the support positions (Figure 5). Crack inspection was monitored by a DSLR camera during the test and crack patterns were captured.

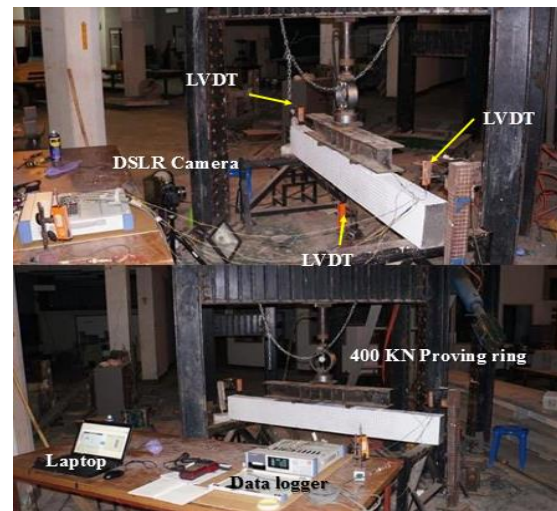

Figure 5. Experimental set-up for reinforced concrete beam.

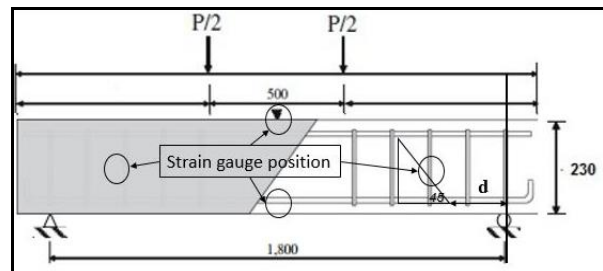

Figure 6. Details of strain gauge attachments.

**3.3.1. Load-deflection results**

The relationships between load and deflection of reinforced concrete beams are shown in Figure 7. It appeared that the mechanical behaviour of all samples was similar. However, CC began to crack, yield, and rupture at a lower load compared to R8 and P1R8 (Table 5) because it was able to dissipate energy less than R8 and P1R8 since in each load, the critical strain on CC was higher than the others (Figures 8 and 9). The results indicate that at the same load, there was more stress on a critical point of CC than R8 and P1R8. Therefore, CC would begin to crack, yield, and rupture earlier than R8 and P1R8.3.

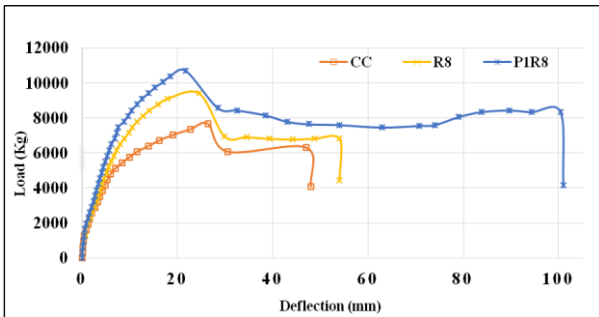

Figure 7. Load-deflection curves of reinforced concrete beams after 28 days of curing.

Table 5. Flexural strength test results of reinforced beam.

Specimens	Compressive Strength at 28 days (Ksc)	Pcr (Kg)	Δcr (mm)	Py (Kg)	Δy (mm)	Pu (Kg)	Δu (mm)
CC	437	960	0.27	4800	6.00	7680	26.39
R8	384	1948	0.52	6169	7.19	9417	25.37
P1R8	411	2273	1.31	6169	5.65	10716	21.77

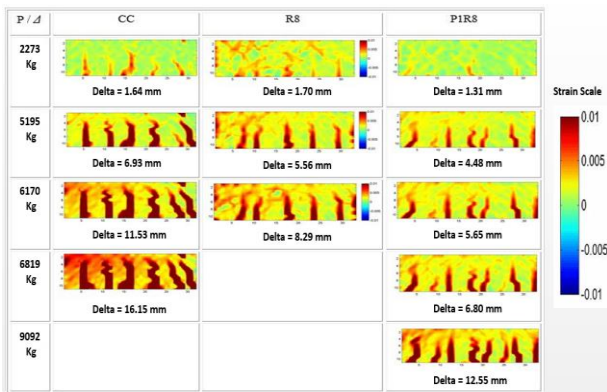

Figure 8. Strain contour of reinforced concrete beams while loading.

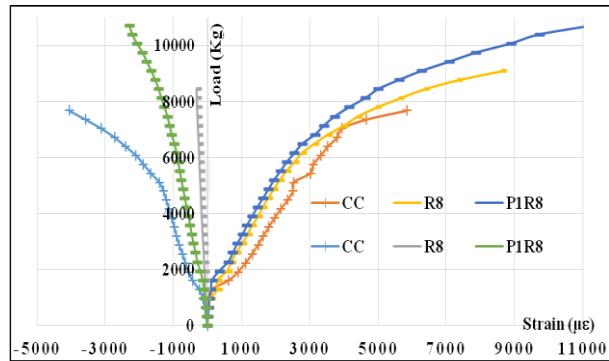

Figure 9. Relationship between strain and load of samples.

**3.3.2. Energy dissipation results**

The area under the load-deflection curve was used to determine energy dissipation of the reinforced beam. The results showed that P1R8 dissipated higher energy compared to CC and R8 by 285% and 211%, respectively (Table 6).

Table 6. Ductility index and energy dissipation of reinforced beam.

Specimens	Pu/Pu (%)	Ductility index (Δu/Δy)	Energy dissipation (Kg m)
CC	100%	4.40	282.36
R8	123%	3.53	381.24
P1R8	140%	3.85	804.28

**3.3.3. Image analysis results**

Strain contours at identical loads were analysed by the numerical approach (Figure 8). Also, a relationship between strain and applied load was plotted (Figure 9). It showed that both R8 and P1R8 had the lowest compressive strain and tensile strain, respectively, at the vulnerable areas of the beams. The results indicated that at the same compressive and tensile strains, R8 and P1R8 were capable of restraining higher loads than CC since, under the circumstances, rubber dissipates energy from compression and PET relieves energy from tension.

**4. Conclusions**

This research aimed to determine the advantages and disadvantages from selecting PET fibre and crumb rubber as supplementary materials in structural concrete. The experimental results in the study of PET fibre and crumb rubber in reinforced concrete can be summarized.

- (1) With lower elastic modulus, P1R8 and R8 showed a reduction in compressive strength by approximately 6% and 12% compared with CC.

(2) The flexural strength of prismatic beams, P1R8 and R8, increased by 24.7% and 2.1%, respectively, relative to CC. Apart from that, energy dissipation of the prismatic beams calculated by the area under the load-deflection curves improved noticeably with increased values of 253% and 58%.

(3) Regarding the analysis of the reinforced concrete beams, considerable evidence was found. At the initial stage of loading, the cracks that formed in CC were ahead of R8 and P1R8 at lower deflections. CC then yielded and collapsed preceding R8 and P1R8.

(4) From image and strain analysis on reinforced concrete beams with the same load at the middle of the beam, R8 produced the lowest compressive strain as crumb rubber was able to dissipate energy from compression. P1R8 had the lowest tensile strain that resulted from its ability to absorb PET fibre energy from the tension and there were delayed cracks and failure of the specimens. As a result, the ultimate loads of P1R8 and R8 were greater than CC by 39.52% and 22.61%, respectively.

(5) Sometimes, the compressive strength of rubberized concrete does not establish the same pattern as conventional concrete. The results in Figure 3 show that the compressive strength of P1R4 was lower than P1R8, which could be possible since there was a claim that "rubberized concrete is unpredictable, failure stress strain relationship does not follow a fixed pattern in experiments at same point" (Issa *et al.*, 2013).

#### Acknowledgements

The authors appreciate the valuable support from Dr. K. Patanukhom who helped us on the numerical approach for image analysis. Also, the writers admiringly acknowledge the staff personnel in the Laboratory of Civil Engineering Chiang Mai University.

#### References

- Batayneh, M. K., Marie, I., & Asi, I. (2008). Promoting the use of crumb rubber concrete in developing countries. *Waste Management*, 28, 2171–2176.
- Department of Highways. (2001), *Standard No. DH-S 309/2544*, Bangkok, Thailand: Author. Retrieved from <http://www.doh.go.th/doh/images/aboutus/standard/01/dhs309-44.pdf>
- Foti, D. (2011). Preliminary analysis of concrete reinforced with waste bottles PET fibers. *Construction and Building Materials*, 25, 1906–1915.
- Fraternali, F., Ciancia, V., Chechile, R., Rizzano, G., Feo, L., & Incarnato, L. (2011). Experimental study of the thermo-mechanical properties of recycled PET fiber-reinforced concrete. *Composite Structures*, 93, 2368–2374.
- Hernández, O. F., Barluenga, G., Parga-Landa, B., Bollati, M., & Witoszek, B. (2007). Fatigue behaviour of recycled tyre rubber-filled concrete and its implications in the design of rigid pavements. *Construction and Building Materials*, 21, 1918–1927.
- Issa, C. A., & Salem, G. (2013). Utilization of recycled crumb rubber as fine aggregates in concrete mix design. *Construction and Building Materials*, 42, 48–52.
- Kaloush, K. E., Way, G. B., & Zhu, H. (2005). Properties of crumb rubber concrete. *Transportation Research Record*, (1914), 8–14.
- Kim, S. B., Yi, N. H., Kim, H. Y., Kim, J. J., & Song, Y. (2010). Material and structural performance evaluation of recycled PET fiber reinforced concrete. *Cement and Concrete Composites*, 32, 232–240.
- Ochi, T., Okubo, S., & Fukui, K. (2007). Development of recycled PET fiber and its application as concrete-reinforcing fiber. *Cement and Concrete Composites*, 29, 448–455.
- Pacheco, T. F., Ding, Y., & Jalali, S. (2012). Properties and durability of concrete containing polymeric wastes (tyre rubber and polyethylene terephthalate bottles): An overview. *Construction and Building Materials*, 30, 714–724.
- Pereira-de-Oliveira, L. A., & Castro-Gomes, J. P. (2011). Physical and mechanical behaviour of recycled PET fibre reinforced mortar. *Construction and Building Materials*, 25, 1712–1717.
- Siddique, R. (2004). Properties of concrete containing scrap-tire rubber – An overview. *Waste Management*, 24, 563–569.
- Youssif, O., ElGawady, M., & Mills, J. (2015). Experimental investigation of crumb rubber concrete columns under seismic loading. *Structures*, 3, 13–27.